

# Mini Microphone

## Omni-direction mini microphone MM6015 Serie

### Specifications:

Sensitivity(1KHz,0dB=1V/Pa): -40±3dB ; -42±3dB ; -44±3dB

Directivity:Omnidirectional

Impedance:2.2KΩ Max.

Current consumption:0.5mA Max.

Operation voltage:1.0~10V

S/N ratio:60dB Min.

Sensitivity vs. Voltage:3dB Max. at VS=2.0V~1.5V

Std. Test Condition:94dB S.P.L @1KHz VS=2.0V

Frequency:20~16,000Hz

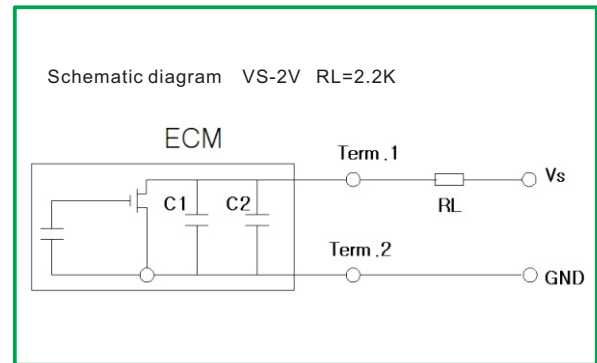
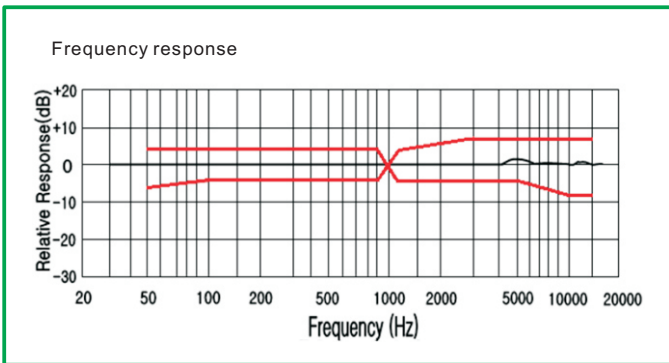
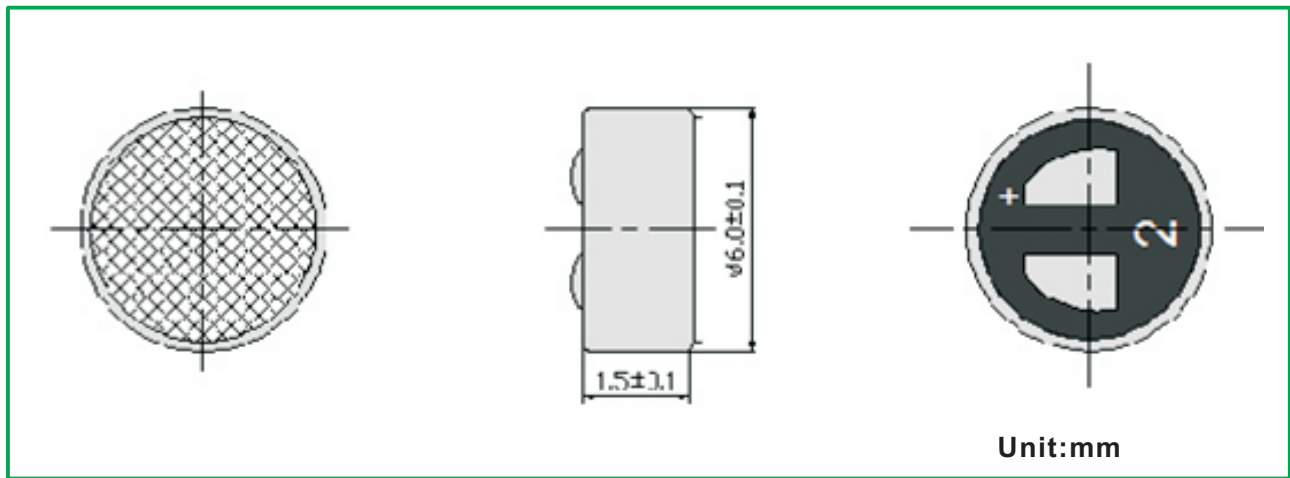

### ORDER INFORMATION

Product NO.: **KLS3 - MM 6015 P - 443**

Omni-Direction mini microphone Series  
 Dimensions  
 Note: Soldering  
 P: Pin Type  
 W: Wire type  
 Sensitivity