

## LED Series

### KLS9-L Ultra Bright LED Lamp Series



KLS9 - L - CM 501 2 G C - XXX  
 1            2            3            4    5    6            7

1. Brank: KLS ELECTRONIC

2. Digit Mode: L-Lamp

3. Package Type (style):

4. Leads Type:

0: Surface Mounting Lead for SMD

2: 18mm Lead Length Standard

4: 25.4mm Lead Length with small Reflector

7: 25.4mm Lead Length with 2 Leads for bi-color

1: 20mm Lead Length with Stand-off

3: 25.4mm Lead Length with big Reflector

5: 25.4mm Lead Length with 3 Leads for bi-color

9: 25.4mm Lead Length with 3 Leads for bi-color

5. Color Code:

H: Red	GaP / GaP	700nm	UG: High Bright Green	AlGaInP 574nm
S: High Bright Red	GaAlAs / GaAs	SH 660nm	PG: Super Pure Green	AlGaInP 525nm
D: Super Bright Red	GaAlAs / GaAs	DH 660nm	BG: Super Bluish Green	AlGaInP 505nm
UR: Ultra Bright Red	GaAlAs / GaAlAs	DDH 660nm	B: Blue GaN / SiC	430nm
UHR: Ultra Bright Red	AlGaInP	640nm	UB: Super Bright Blue	InGaN / SiC 470nm
E: Orange	GaAsP / GaP	635nm	V: UV	InGaN / SiC405nm
UE: High Bright Orange	AlGaInP	630nm	W: White	
Y: Yellow	GaAsP / GaP	585nm	EG: Orange + Green Bi-Color	
UY: High Bright Yellow	AlGaInP	590nm	SG: High Red + Green Bi-Color	
G: Green	GaP / GaP	568nm	RGB: Multicolor	

6. Len Color: D: Color Diffused

T: Color Transparent

C: Water Clear

W: White Diffused

CD: Color Top Diffused

WD: White Top Diffused

E: Orange Diffused

7. Special Operation & Other:

## NOTES

- All dimensions are in millimeters .
- Tolerance is  $\pm 0.25$ mm unless otherwise noted.
- Protruded resin under flange is 1.0mm max.
- Lead spacing is measured where the leads emerge from the package.
- Specifications are subject to change without notice.

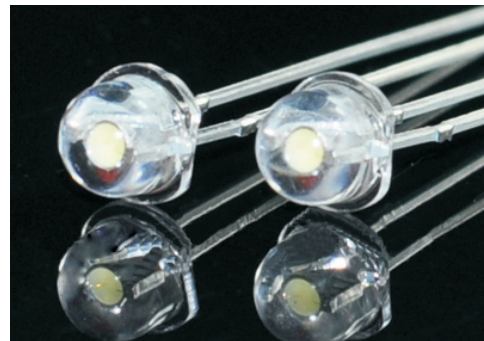

Lens	Material	Emitting Color
Water Clear	InGaN	Super Green

## LED Series

### KLS9-L Ultra Bright LED Lamp Series

IX

#### Package Dimensions

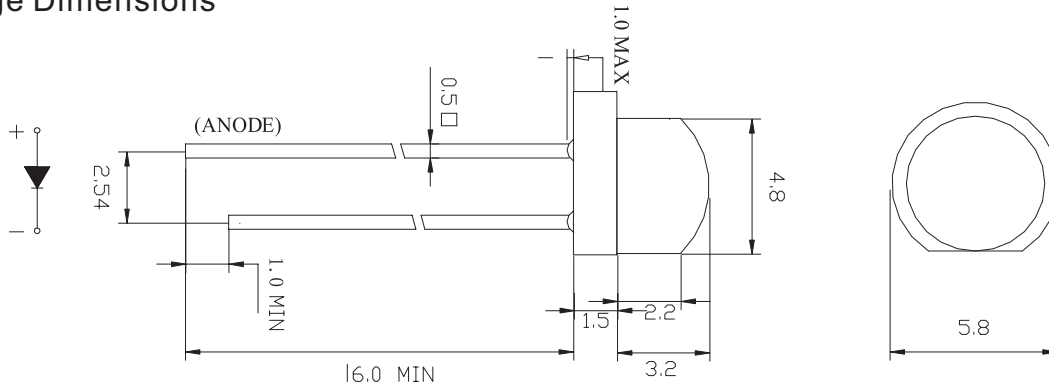

#### Absolute Maximum Ratings at TA=25°C

Parameter	Maximum Rating	Unit
Power Dissipation	100	mW
Peak Forward Current (1/10 Duty Cycle, 0.1ms Pulse Width)	60	mA
DC Forward Current	30	mA
Reverse Voltage	5	V
Operating Temperature Range	-20°C~+80°C	
Storage Temperature Range	-40°C~+100°C	
Lead Soldering Temperature [1.6mm(.063") From Body]	260°C for 5 seconds	

#### Electrical Optical Characteristics at TA=25°C

Parameter	Symbol	Min.	Typ.	Max.	Unit	Test Condition
Luminous Intensity	$I_v$	800	1500	/	mcd	IF=20mA
Viewing Angle	$2\theta_{1/2}$	/	20°	/	deg	IF=20mA
Peak Emission Wavelength	$\lambda_p$	/	/	530	nm	IF=20mA
Dominant Wavelength	$\lambda_d$	/	520	/	nm	IF=20mA
Spectral Line Half-Width	$\Delta\lambda$	/	30	/	nm	IF=20mA
Forward Voltage	VF	2.8	3.3	3.8	V	IF=20mA
Reverse Current	IR	/	/	40	uA	VR=5V

- Note: 1. Luminous intensity is measured with a light sensor and filter combination that approximates CIE (Commission International de l'Eclairage) eyes response curve.  
 2.  $\theta_{1/2}$  is the off-axis angle at which the luminous intensity is half the axial luminous intensity.  
 3. The dominant wavelength,  $\lambda_d$  is derived from the CIE chromaticity diagram and represents the single wavelength which defines the color of the device.  
 4. The  $I_v$  guarantee should be added  $\pm 15\%$ .

**LED Series**

**KLS9-L Ultra Bright LED Lamp Series**



Typical Electrical / Optical Characteristics Curves  
(25°C Ambient Temperature Unless Otherwise Noted)

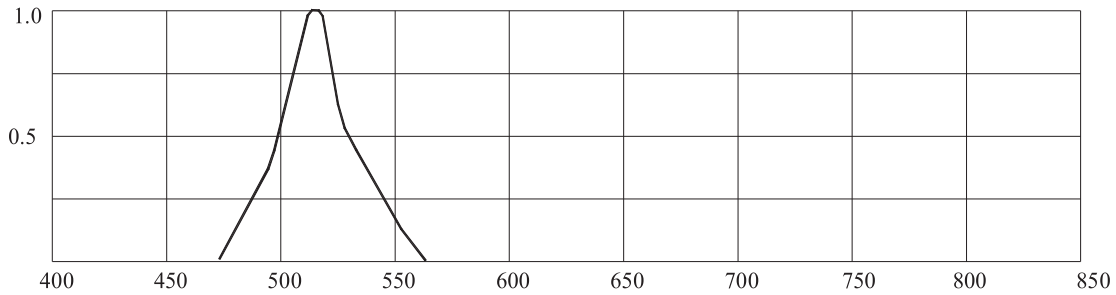

Wavelength  $\lambda$  (nm)  
Fig. 1 Relative Intensity vs . Wavelength

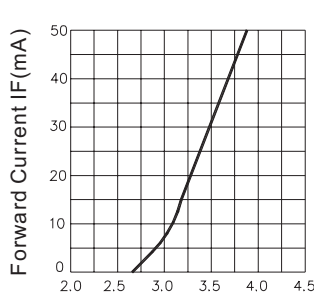

Forward Voltage VF(V)  
Fig.2 Forward Current vs.  
Forward Voltage

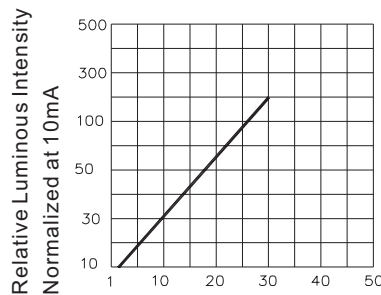

Forward Current(mA)  
Fig.4 Relative Luminous Intensity  
vs.Forward Current

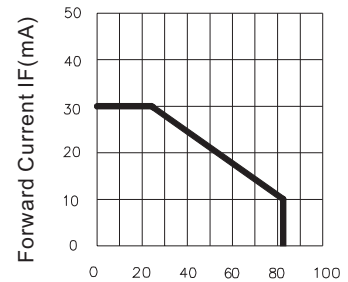

Ambient Temperature TA(°C )  
Fig.3 Forward Current  
Derating Curve

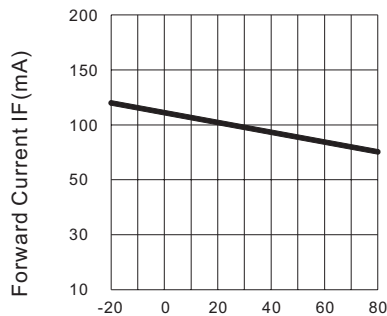

Ambient Temperature TA(°C )  
Fig.5 Luminous Intensity vs  
Ambient Temperature

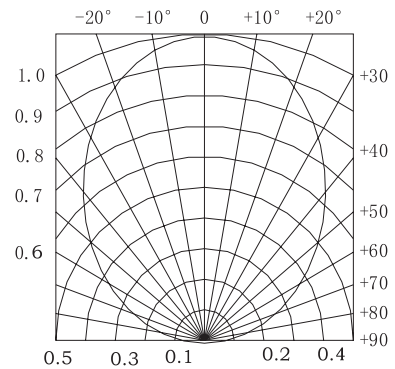

Emitted Angle 100°

## LED Series

### KLS9-L Ultra Bright LED Lamp Series

#### CAUTIONS

##### 1. Application

The LEDs described here are intended to be used for ordinary electronic equipment (such as office equipment, communication equipment and household applications). Consult MLS's Sales in advance for information on applications in which exceptional reliability is required, particularly when the failure or malfunction of the LEDs may directly jeopardize life or health (such as in aviation, transportation, traffic control equipment, medical and life support systems and safety devices)

##### 2. Storage

The storage ambient for the LEDs should not exceed 30 °C temperature or 70% relative humidity. It is recommended that LEDs out of their original packaging are used within three months. For extended storage out of their original packaging, it is recommended that the LEDs be stored in a sealed container with appropriate desiccant or in desiccators with nitrogen ambient

##### 3. Cleaning

Use alcohol-based cleaning solvent such as isopropyl alcohol to clean the LEDs if necessary.

##### 4. Lead Forming & Assembly

During lead forming, the leads should be bent at point at least 3mm from the base of LED lens. Do not use the base of the lead frame as a fulcrum during forming. Lead forming must be done before soldering, at normal temperature. During assembly on PCB, use minimum clinch force possible to avoid excessive mechanical stress.

##### 5. Soldering

When soldering leave a minimum of 2mm clearance from the base of the lens to the soldering point. Dipping the lens into the solder must be avoided. Do not apply any external stress to the lead frame during soldering while the LED is at high temperature.

Recommended soldering conditions:

Soldering iron		Wave soldering	
Temperature Soldering time	300°C Max	Pre-heat	100°C Max
	3 sec. Max	Pre-heat time	60sec. Max
	(one time only)	Solder wave	260°C Max
		Soldering time	8sec. Max

Note: Excessive soldering temperature and/or time might result in deformation of the LED lens or catastrophic failure of the LED.

##### 6. Drive Method

An LED is a current-operated device. In order to ensure intensity uniformity on multiple LEDs connected in parallel in an application, it is recommended that a current limiting resistor be incorporated in the drive circuit, in series with each LED as shown in Circuit A below.

Circuit model A

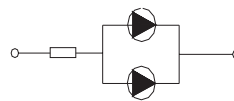
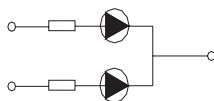

(A) Recommended circuit

(B) The brightness of each LED might appear different due to the differences in the I-V characteristics of those LEDs.

##### 7. Protect Of ESD

Since the device is static sensitive, it is requested that anti-static measures should be taken on human body, all devices (including soldering iron) and equipment, machinery, desk and ground.

## LED Series

### KLS9-L Ultra Bright LED Lamp Series

IX

#### 8. Reliability Test

Classification	Test Item	Ta=Under Room Temperature As	Sample Size	Ac/Re
Endurance Test	Operation Life	Per Data Sheet Maximum Rating *Test Time=1000HRS(-24HRS,+72HRS)	22PCS	0/1
	High Temperature Storage	Ta=100±5°C *Test Time=1000HRS(-24HRS,+72HRS)	22PCS	0/1
	Low Temperature Storage	Ta=-40±5°C *Test Time=1000HRS(-24HRS,+72HRS)	22PCS	0/1
Environmental Test	Temperature Cycling	85°C ~ 25°C ~ -40°C ~ 25°C 30mins 5mins 30mins 5mins 10Cycles	22PCS	0/1
	Thermal Shock	85°C±5°C ~-40°C±5°C 10mins 10mins 10Cycles	22PCS	0/1
	Solder	T.sol=260±5°C Dwell Time=10±1secs	22PCS	0/1

#### 9. Others

The appearance and specifications of the product may be modified for improvement, without prior notice.